

Countertop Technical Guide

NEOLITH

Index

- 0.1 Formats and Thicknesses
- 0.2 Color Range
- 0.3 Product Features
- 1. Handling Neolith Countertops
- 2. Inspection of the slabs
- 3. Machining parameters
- 4. Cut-out recommendations
 - 4.1 General Recommendations
 - 4.2 Bridge Saw, combi machine or similar
 - 4.3 Waterjet
 - 4.4 CNC Machine
- 5. Edges and profiles recommendations
 - 5.1 Polishing
 - 5.2 Countertop edges
 - 5.3 Sinks
- 6. Installation
 - 6.1 Reinforcement
 - 6.2 Preparing cabinets
 - 6.3 Overhangs
- 7. Recommended tools for machining countertops
- 8. Cleaning and maintenance of Neolith countertops
 - 8.1 Maintenance
 - 8.2 Suggested detergents to clean general stains
- 9. Guide for repairing Neolith surface defects caused by chipping

0.1 Formats and Thicknesses

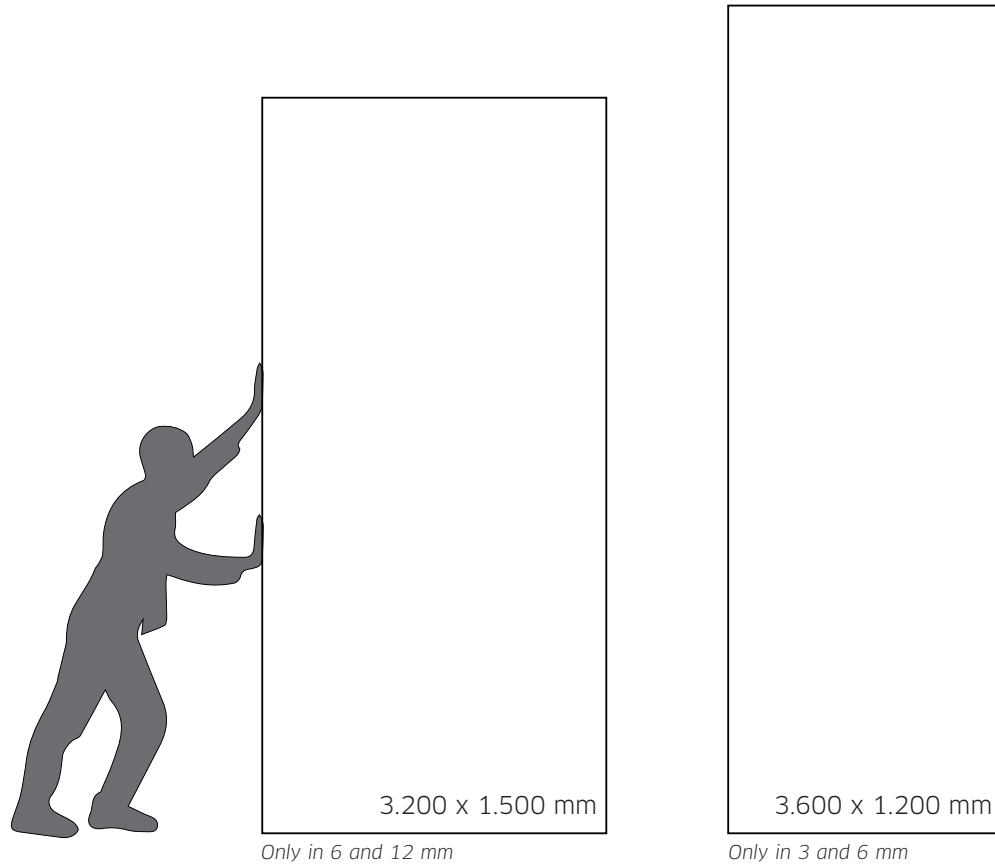

3 mm

6 mm

12 mm

0.2 Color Range









	Arctic White		Beton
	Nieve		Phedra
	Aporio		Cement
	Perla		Lava
	Humo		Basalt Grey
	Moka		Basalt Black
	Chocolate		Belgian Blue
	Nero		Barro
	Cobalto		Basalt Beige
	Mela		Arena
	Arancio		Estatuario
	Timber Oak		Calacatta
	Timber Night		Onyx
	Timber Ash		Marfil
	Timber Ice		Travertino Navona
	Textil White		Travertino Clasico
	Textil Black		Pulpis
	Pietra di Osso		Iron Grey
	Pietra di Luna		Iron Moss
	Pietra di Piombo		Iron Copper
	Nero Zimbabwe		Iron Corten
	Nero Assoluto		Iron Ash
			Iron Blue

0.3 Product Features

Neolith is the largest sintered compact surface available in the market. It is 100% natural product composed of feldspar, silica, clay and other natural minerals and it emulates what nature takes millennia to produce in just a few hours, through an exclusive and high technological sintering process. Neolith offers the most efficient solutions for the most demanding architectural projects, as well as an extensive combination of colors and finishes, making it a designer product that can be used in numerous applications for interiors, exteriors and furnishings.

Neolith presents physical properties that excel for its use on any application, furthermore, its colors made of 100% natural pigments, withstand the passage of time and remain unvariable.

Technical Features:

-  Lightweight: The thickness of the slabs makes it a very light product and thus facilitates transportation and handling and reduces the load factor on cladding. 7kg/m² for the 3mm option.
-  Waterproof: Neolith sintering process confers the slabs less than 0,08% porosity. It does not absorb any water and it is resistant to stains, making it ideal for humid places.
-  UV Resistance: Being 100% natural, its colors do not fade away when being exposed to sun light or other extreme weather conditions.
-  Resistant to High temperatures: It does not burn in contact with fire nor does it emit smoke or toxic substances when being subjected to high temperatures
-  Resistance to wear and tear: Its hard surface makes it resistant to scratches and abrasion when being exposed to extreme weather conditions (such as sand storms or other similar aggressions).
-  Bending resistance: It has a high share rate, making it resistant to heavy loads and pressure as well as suitable for some curved applications.
-  Environmental-friendly: Composed entirely of natural material, completely recyclable. Up to 52% of recycled content. Greenguard, CE, NSF1 certifications. Its use in buildings grants LEED points to the project.
-  Easy To Clean: Resistant to any kind of chemical cleaning agent such as bleach or ammonia. When used in exterior cladding, this characteristic proves of high-added-value in areas with high pollution levels and risk of graffiti criminality.
-  Hygienic: Given its practically nul-porosity, it does not trigger any bacteria or fungus which may lead to allergies or illnesses.

1. Handling

Neolith slabs must be loaded, unloaded and transported by means of a forklift, gantry crane or other lifting device. In every case of handling and transport, the slabs should be balanced considering its center of gravity.

In the attached table is an overview of the weight per slab and weight per square meter.

FORMAT (mm)	3600 x 1200							3200 x 1500	
THICKNESS (mm)	3	3+	5	5+	3+3	5+3	5+5	6+	12
Kg/m ²	7	8	13	14	17	22	27	18	30
Full Slab Weight (Kg)	32	36	55	59	72	94	116	85	143
Weight per m ²	7	7,5	12	12,5	15	20	25	17	28

Table 1: Formats and Weights per thickness

Always pay attention when moving and manipulating the slabs, to avoid chipping or breakage of the slab. To lift and move individual slabs, The Size recommends the following type of clamp:



Image 1: Clamp



Image 2: Neolith slab handling with Clamp

This clamp can be purchased through TheSize. Please contact TheSize for more details.

In the case that this type of clamp is not readily available, use a 2 cm. thick plank of roughly 3 meters x 20 cms. Place the plank in between the slab you want to lift. Make sure the plank is placed on the backside of the slab.



Image 3: Plank in the backside of the slab



Image 4: Handling with Clamp

- 1) Place the clamp over the slab and the plank.
- 2) Fix the clamp and lift the slab with caution.
- 3) Try to avoid sudden changes of direction.

To move several slabs at once it is recommended to use canvas slings. Metallic slings should not be used to handle Neolith slabs.



Image 5: Canvas Slings



Image 6: Moving a Neolith Slab



Image 7: Moving a Neolith Slab



Image 8: Placing a Neolith Slab on a bench



Image 9: Placing a Neolith Slab on a bench



2. Inspection of the slabs

Before commencing fabrication, TheSize recommends to clean the slab thoroughly and perform a careful visual inspection of the slab for:

- Pigment contaminations.
- Blisters, cracks & fissures.
- Warping.
- Tonality.
- Any other anomaly that might be considered a defect.

This should be a standard procedure before commencing fabrication: No claims will be accepted of mechanized or installed slabs that had defects upon delivery.

3. Machining Parameters

 Recommendations for 12 mm slabs only.

Before fabrication starts it is important to remove +/-2 cm from each side of the slab in the following order:

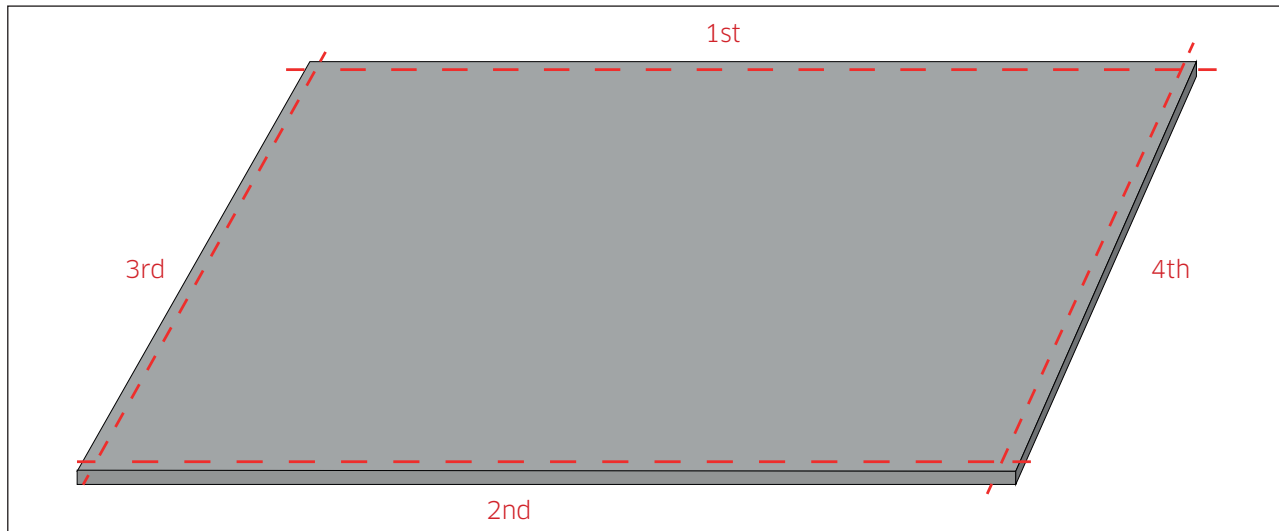

Image 11: Correct order to remove slabs sides

When cutting 12mm slabs with a disc, it is important to reduce the cutting speed at the beginning and the end of the cut to about 50%.

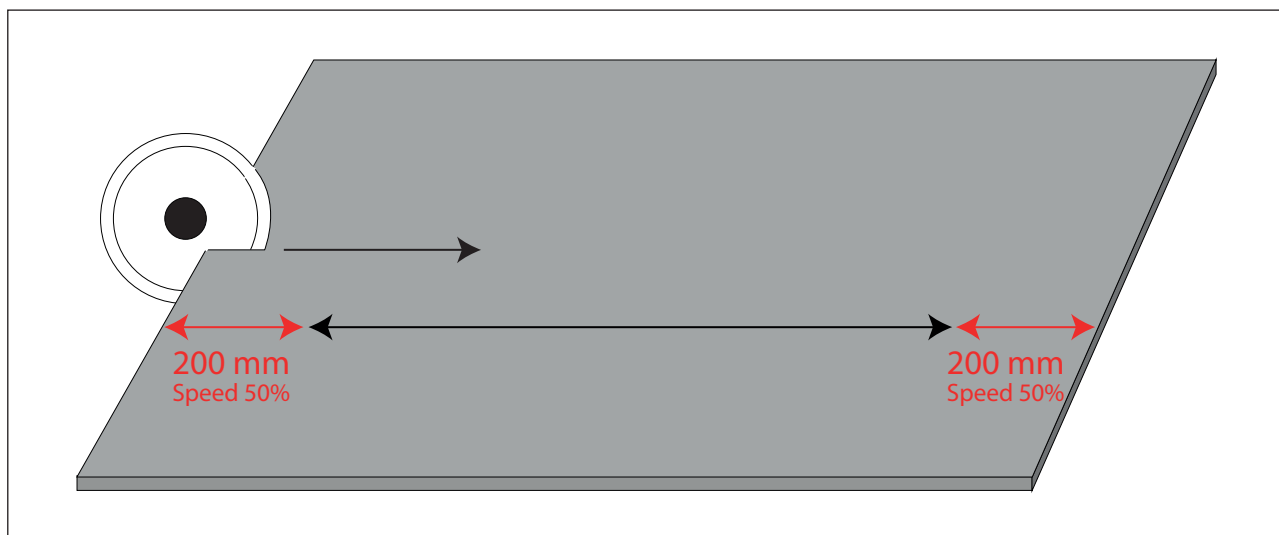



Image 12: Cutting speed recommendations for 12 mm

 These recommendations only apply to **12mm slabs only**. All other thickness can be cut without taking in account these steps.

Disc:

Thickness (mm)	Speed (mm/min) straight	Speed (mm/min) miter	Ø Disc (mm)	RPM	Surface Speed (m/s)
3 mm	2,5 - 3,0	1,7 - 2,1	300	2500	40
			350	2200	
			400	1900	
5, 6 and 3+3 mm	2,2 - 2,7	1,5 - 1,9	300	2500	40
			350	2200	
			400	1900	
5+3 mm	2,0 - 2,4	1,4 - 1,7	300	2500	40
			350	2200	
			400	1900	
12 mm	1,0 - 1,5	0,7 - 1,0	300	2500	40
			350	2200	
			400	1900	

Table 3: Disc Parameters

During cutting it is important to use the maximum flow of water for cooling. Make sure the flow of water is directed to the cutting area.

Verify that the cutting table is straight, level and free of any debris. Check that there is sufficient support for the slab. Large unsupported areas can cause chipping when cutting.

Lighter models (Arctic White, Estatuario, Nieve and Avorio) are harder on the discs because of certain raw materials; THESIZE recommends lowering the cutting speeds for these models to avoid overheating of the disc.

Waterjet:

Pressure (Bars)	Speed (mm/min)	Abrasive feed (kgs/min)
3800	700	0,38

Table 4: Waterjet parameters for all thicknesses



The indicated values are suggestions only, cutting speeds or abrasive feeds can be adjusted to obtain a cleaner finish.

CNC:

Tool	RPM	Speed (mm/min)
Core Drill	4.500 - 5.500	20
Finger Bit	4.500 - 5.500	200
Rebate Bit	8.000 - 10.000	300

Table 5: CNC Parameters



- **Rebate Bit:** First drill a whole to work from using the core drill bit. Do not lower the rebate bit directly onto the surface. During the first two passes only remove 0,5mm; afterwards, 2mm can be removed per pass.
- **Finger Bit:** Do not use the oscillation option while cutting; this might provoke chipping

4. Cut-out Recommendations

4.1 General Recommendations:

When fabricating a cut-out, please bear in mind that the minimum distance between a cut-out and the edge of the slab should be at least 5 cm.

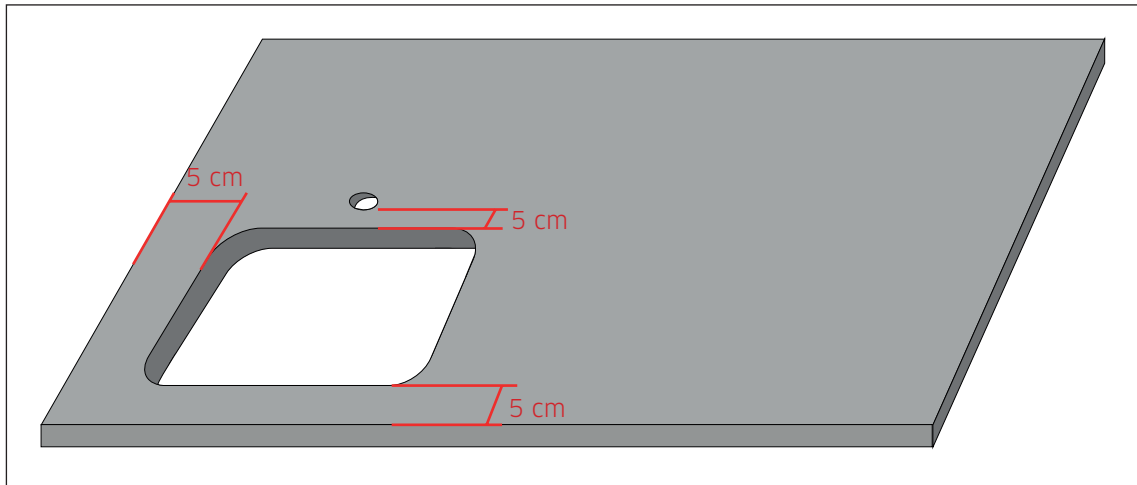

- The distance between a hole for a faucet and the cut-out should be at least 5cm.
- All corners need to have at least a 3mm radius.
- Never leave 90° angles.

Image 13: General recommendations for cut-outs

4.2 Bridge Saw, Combi machine or similar:

Recommendations:

- Drill all the corners of the cut-out.
- Lower the sawblade with minimum speed onto the surface. (10mm/m)
- Make sure the blade is sharpened and has maximum cooling.

4.3 Waterjet:

It is recommended to start inside the cut-out and approach the cutting line afterwards.

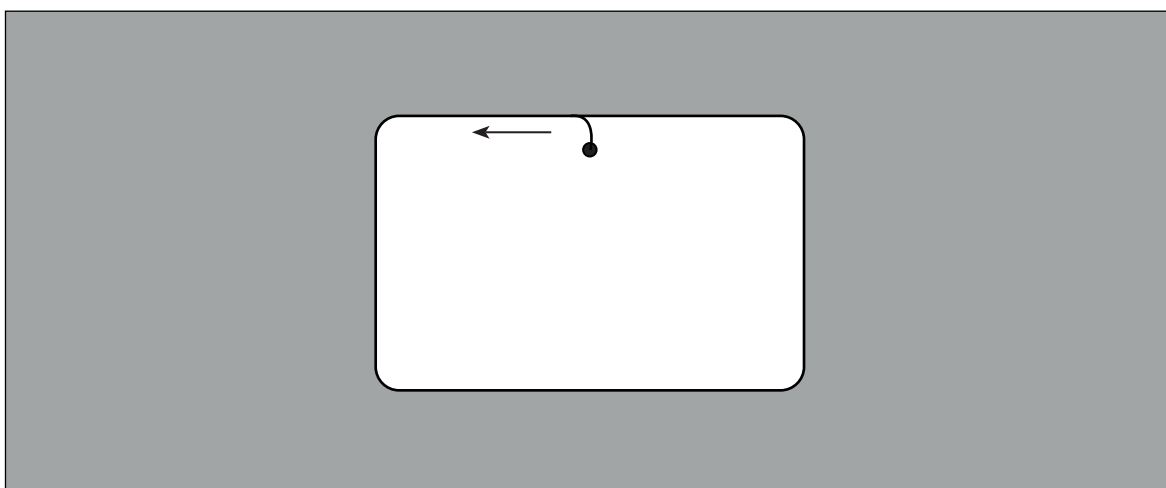

Image 14: Cut-outs with Waterjet

4.4 CNC Machine:

First drill a hole inside the cutout using the core drill bit. Afterwards, use the finger bit to approach the cutting line.

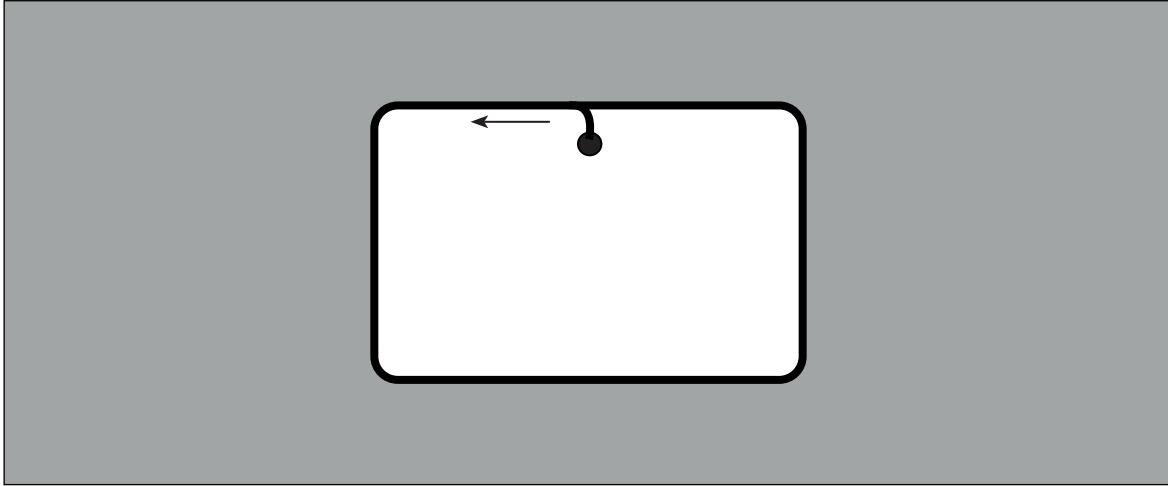

Image 15: Cut-outs with CNC

When approaching the cutting line, use a curved approach; do not use a perpendicular approach, this might create a notch.

Place suction cups around and underneath the cut out as shown in the picture (dotted lines). Furthermore, place the maximum amount of suction cups underneath the slab to prevent the slab from moving.

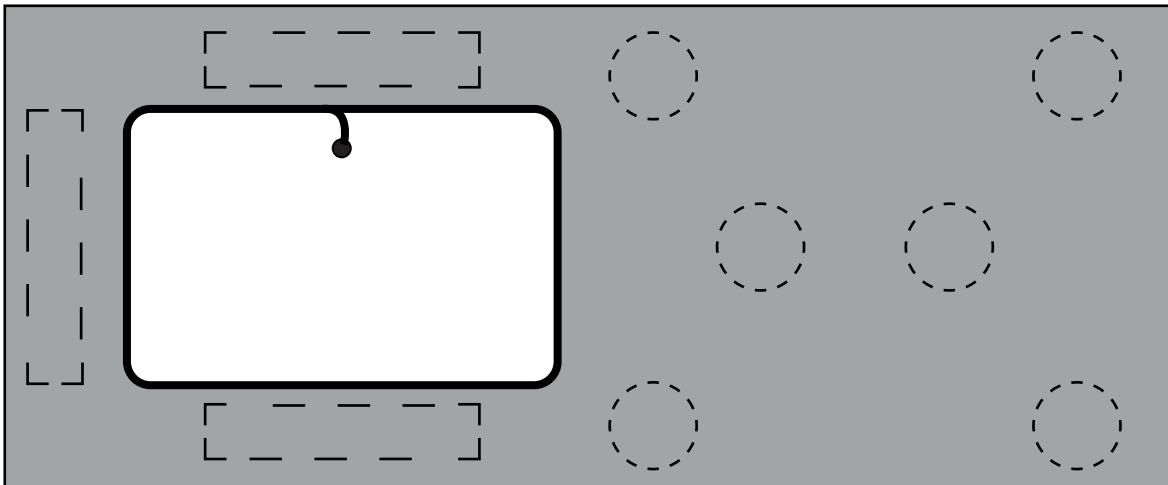

Image 16: Cut-outs with CNC. Suction cups placement

5. Edges and Profiles recommendations

5.1 Polishing:

Edges can be polished using standard granite or marble polishing discs. Start off with the lowest grit and finish with the highest grit.

IMPORTANT

Polished edges should be treated with a water repellent to permanently seal the edge. TheSize recommends *NANOTOP* from *LITHOFIN*.



Image 17: Polishing discs for wet and for dry usage



5.2 Countertop edges:

TheSize recommends the following edge for Neolith countertops. It has been proven to be the perfect compromise between aesthetics and functionality **reducing dramatically the edge chipping incidences.**

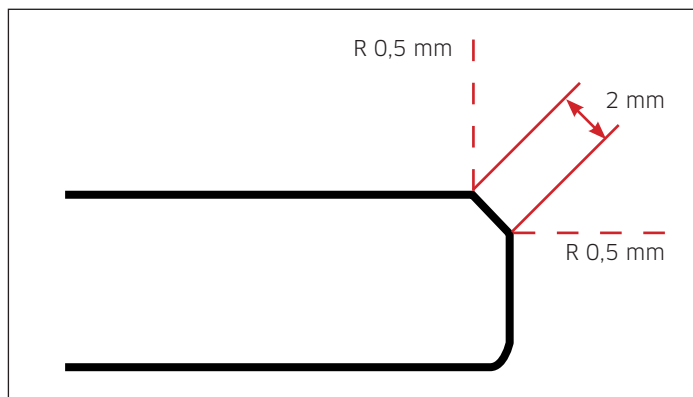

Image 18: Recommended edge section

The edge is made up off a 2mm bevel and two rounded edges with a 0,5mm radius. The radius is hardly visible but it increases the impact resistance of the edge.

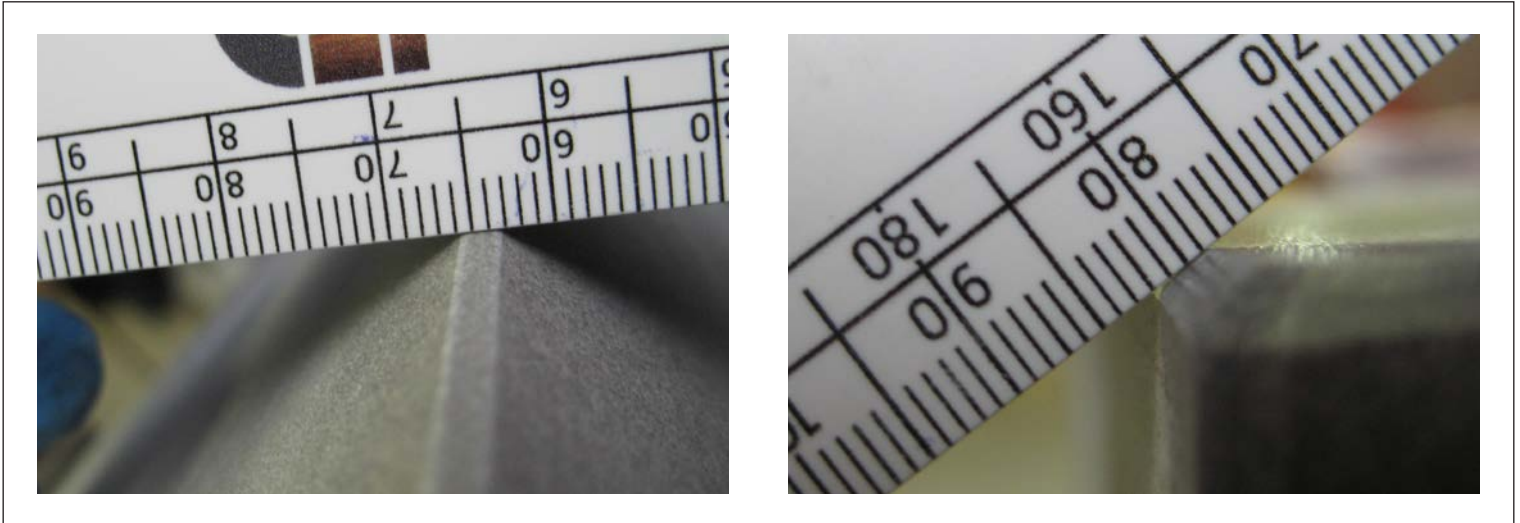

Image 19: Recommended edge detail

Another type of edge that is more resistant to impacts is a radius bevel:

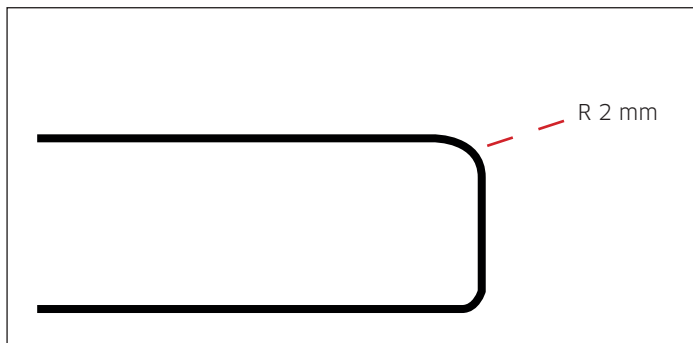

Image 20: Recommended edge section

The bigger the radius the better it will withstand impacts but it will also show more of the base colour of the slab. In areas with a high risk of impact (sinks for example) a 2mm Radius Edge could be considered; it is the best option between aesthetics and durability.



The edges portrayed here can also be applied on mitered edges.

5.3 Sinks:

To minimize the risk of chipping, TheSize recommends the following finish for undermount sinks:

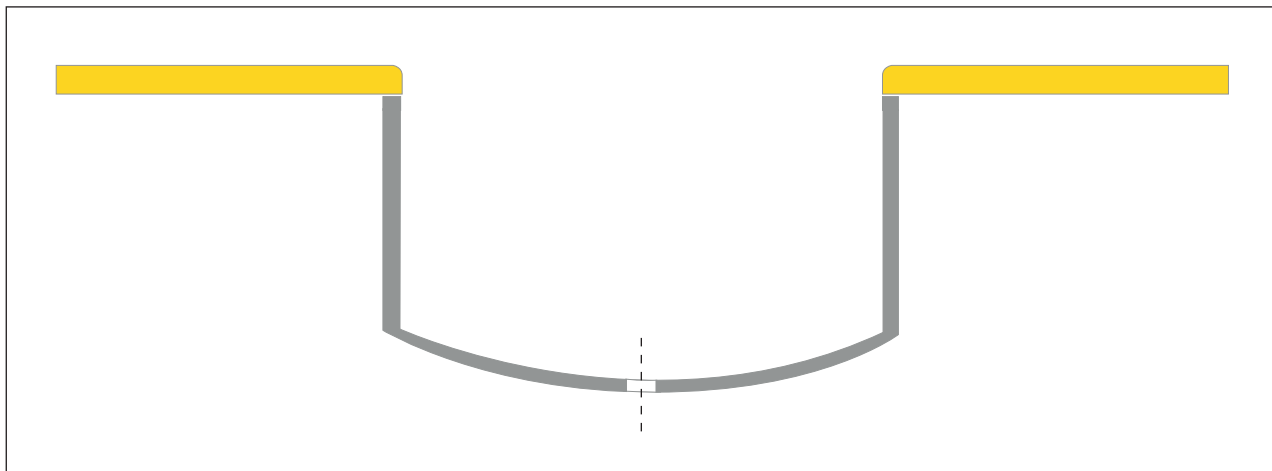

Image 21: Recommended sink section

The countertop meets the edge of the sink, fitting flush with the sink bowl. (zero/flush reveal). In areas with high risk of impact it is recommended to use a top mount sink.

6. Installation

6.1 Reinforcement:

Cut-outs not supported by a solid sub-surface should be reinforced with a suitable material such as granite strips, aluminum bars or high density polyurethane foam strips.

Fabricate back to front supports under the countertop every +/- 600 mm. If a cut-out is bigger than 600 mm, reinforcements should be installed along the perimeter of the cut-out.

All seams should be reinforced underneath.

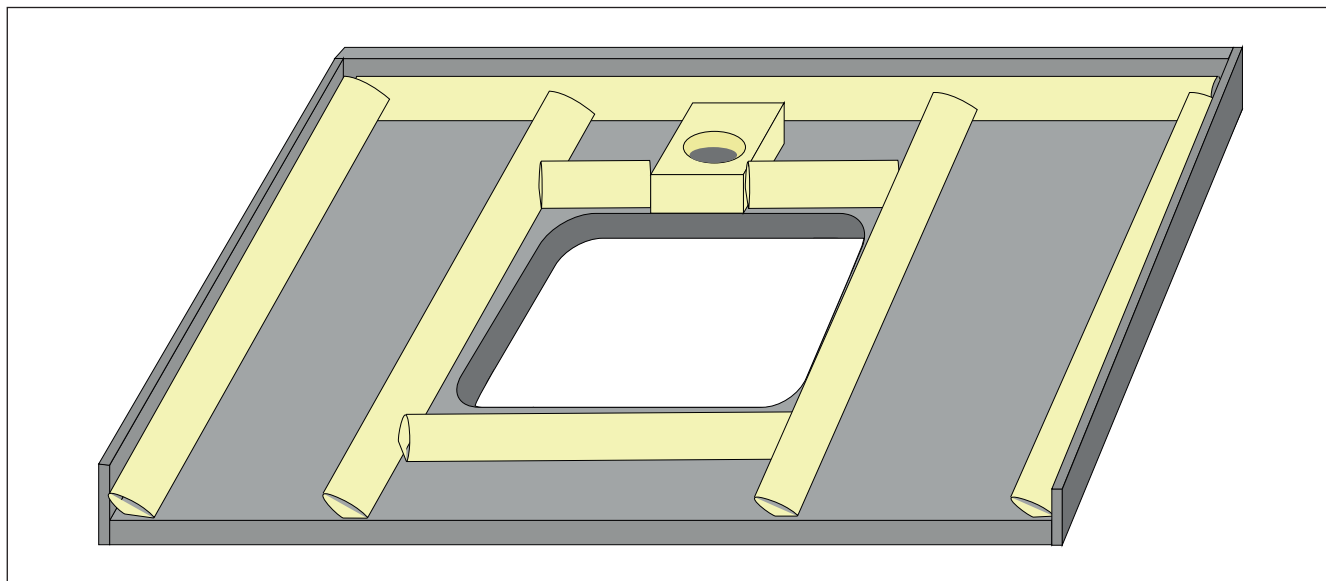

Image 22: Recommended reinforcements

6.2 Preparing cabinets:

Preparation:

1. Place all the manufactured sections of the countertop on the cabinets without adhesive. Check that all the sections are the correct size, shape relative to the cabinets and the walls.
2. Use wedges to level the countertop and fill in the spaces between the countertop and the cabinets with natural silicone.
3. Check that the countertop is straight and level.
4. Make a last visual examination to ensure that the countertop is to your satisfaction.

Sealing between the countertop and wall:

1. Clean the space of any debris.
2. Fill the space generously with natural silicone.

6.3 Overhangs:

Countertops extend out from the face frame of the cabinets and just over the cabinet doors. This is called the overhang. Standard cabinet frames are 60cm deep with 1,5cm to 2,5 cm thick doors. Most countertops have a 2,5 cm overhang to make a standard depth of +/- 63 cm.

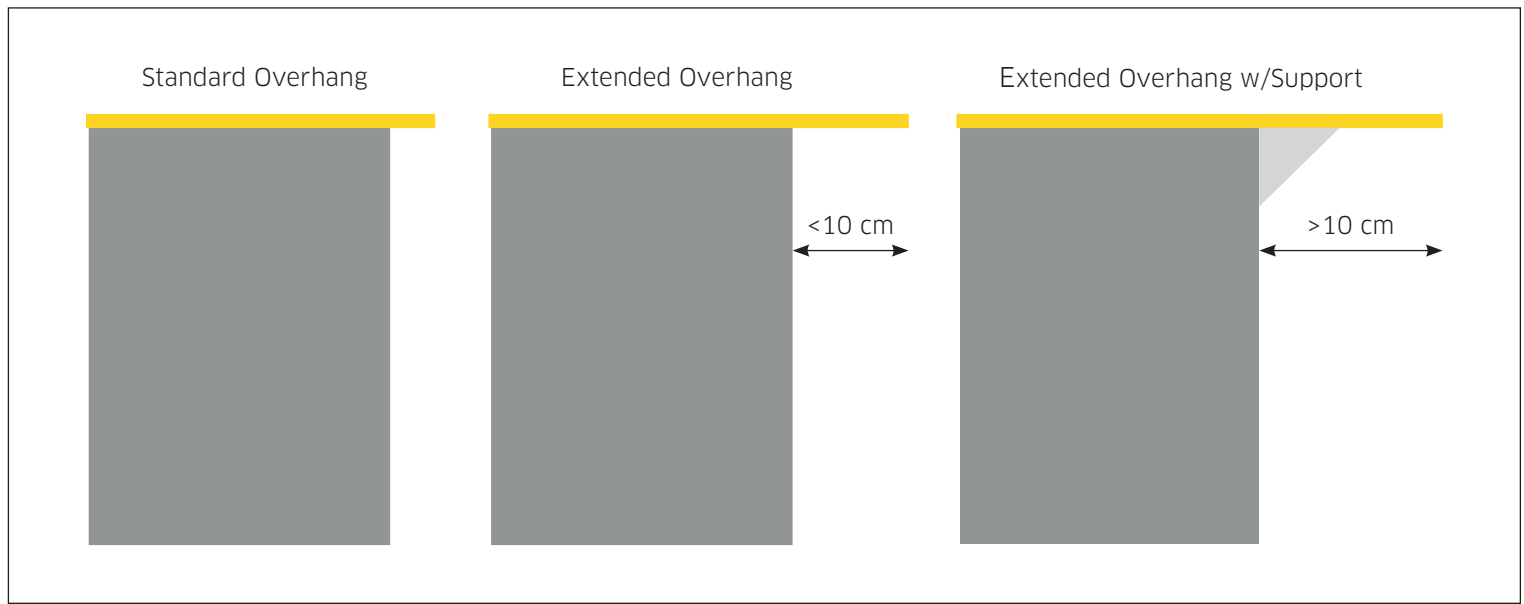

Image 23: Overhangs

If you have the space, and would like to create additional countertop space, you can extend your overhang. It is important to keep in mind that countertops with an extended overhang might require additional support:

Maximum overhang:

- Without apron edge:

12 mm countertops	15 cm.
5+3 cm countertops	10 cm.
- Mitered edge with reinforcement:

12 mm and 5+3 countertop	30 cm*
--------------------------	--------

* Taking in account that the countertop has been reinforced all around the edge and front to back support every 600 mm.

7. Recommended tools for machining countertops



Ø 300 Ref. 720-172
Ø 350 Ref. 720-174
Ø 400 Ref. 720-176

Blades:

Segmented blade for porcelain.



Silicon carbide discs:

Silicon Carbide velcro discs for dry use.
Grit 60, 120, 220, 400.
Ref: Depending on diameters and grits.



Thin Grit G40, Ref. 720-008
Hard Grit. G100, Ref. 720-009

Electroplated diamond grinding disc, type, G100 and G40:

Refining and trimming edges.



Felt pad

Ø 125 Ref. 720-181
Ø 180 Ref. 720-064



Beveling and pre-grinding edges:

Cup wheels, medium, grain 60.
Ref. 720-061



Silicon carbide discs:

Silicon Carbide velcro discs for wet use.



Core drill 20-35 mm:

Electroplated diamond, cutting drill bits.
Ref. Ø35: 411-018



Finger bit:

Ref. 720-107



Drill bits 6-12 mm

Electroplated diamond, cutting drill bits.
Use the drill without the hammer action. Use water for cooling.

Ø 6 Ref. 853-099
Ø 8 Ref. 853-098
Ø 10 Ref. 853-097



Core drill:

Ref. 720-165



4" Diamond blade:

Segmented blade for porcelain. Recommended speed 11.000 RPM. Ref. 720-164



Rebate Cutter:

Ref. 720-210

8. Cleaning and maintenance of Neolith Countertops

8.1 Maintenance:

Neolith countertops can be washed with warm water, to which a detergent can be added, used in the dose recommended by the manufacturer. (Avoid products containing hydrofluoric acid and its derivatives). Rinse with warm water and dry with a cloth or similar.

If liquids are spilled, it must be dried immediately. The faster you clean and dry spills, the easier it is to remove stains.

It is not advisable to use waxes, oily soaps, impregnating agents or other treatments (hydro-oil repellent) on the product, because its application is not necessary at all.

Some of the detergents currently on the market contain waxes or polishing additives that, after several washes, **can leave an oily film** on the surface of Neolith.

TIP:

During treatment, closely examine the spot. If the spot is still there, but is lighter or reduced, you know the treatment is working. Keep applying until the stain is completely gone.



Image 24: Lemon juice on an Arctic White countertop

8.3 Suggested detergents to clean general stains:

Some products may not be removed by normal cleaning operations and specific procedures must be used, depending on their nature. The amount of time the substance remains on the surface is very important, as it is advisable to clean the area as soon as possible. This will prevent it from drying out and allows to be cleaned easily.

Here are some of the substances listed for removing stains.

Types of Stains

Grease
Oil
Ink
Rust
Lime
Cement
Wine
Coffee
Rubber
Plaster
Epoxy glues
Candle wax
Iodine
Blood
Ice cream
Resins
Fruit juice
Permanent marker
Aluminum scratches

Types of detergents

Alkaline / Solvent
Solvent
Oxidant / Solvent
Acid
Acid
Acid
Alkaline / Acid
Alkaline / Solvent
Solvent
Acid
Solvent
Solvent
Oxidant
Oxidant
Alkaline
Solvent
Oxidant
Solvent
Acid



Image 25: Coffee stains on an Arctic White countertop

Acid: Acidic cleaning products: descalers, cement removers...

Alkaline: Basic cleaning products: ammonia, degreasers...

Solvent: Universal solvent, thinner, turpentine, acetone, alcohol...

Oxidant: Diluted hydrogen peroxide or bleach ...



Warning:

Always follow the manufactures' recommended dosage and time

9. Guide for repairing Neolith surface defects caused by chipping

Ceramic surfaces can get damaged for a variety of reasons. Most often it's due to an impact from a heavy object such as cooking pots.

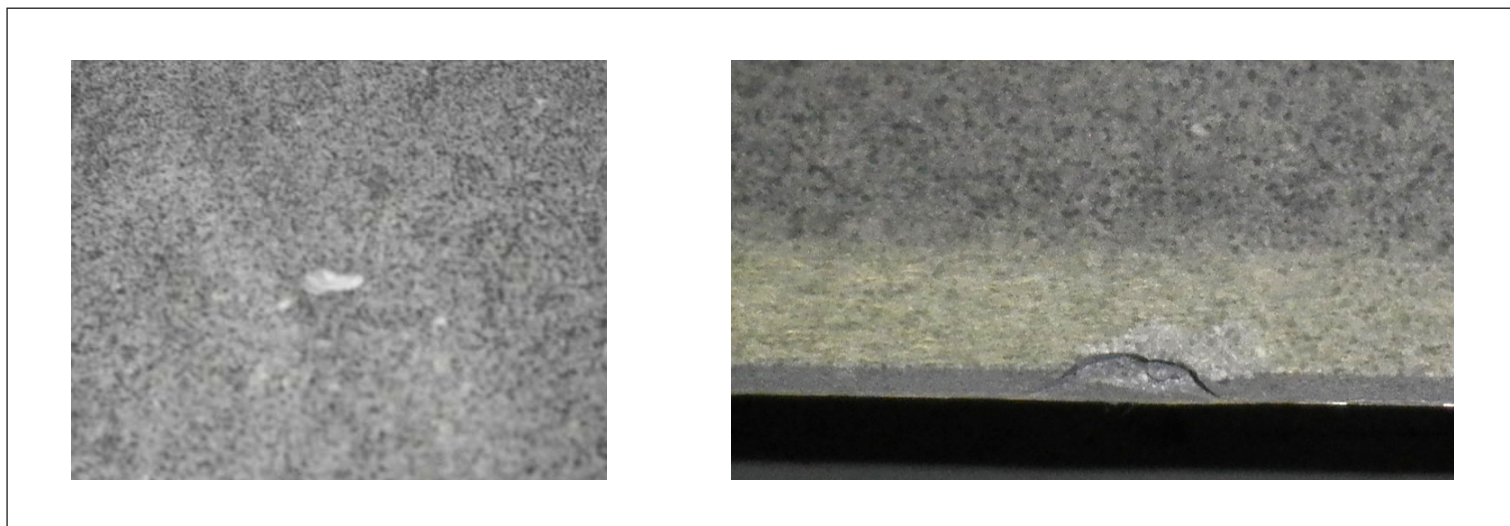

Image 26: Surface and edge chipping

Step 1:

This guide explains how to repair a chipped surface. Bear in mind that it is **not a perfect repair; it is very difficult to match the tonality and texture of the surface with epoxy acrylate resins.**

Step 2:

Mix the two part epoxy, adding the color to tint the epoxy to match your Neolith countertop.

TIP:

Plan on repairing all of the chips at one time, because the two part epoxy will cure quickly. Also, only mix enough so you can fill the chips and have a little left over: epoxy cannot be stored once mixed.

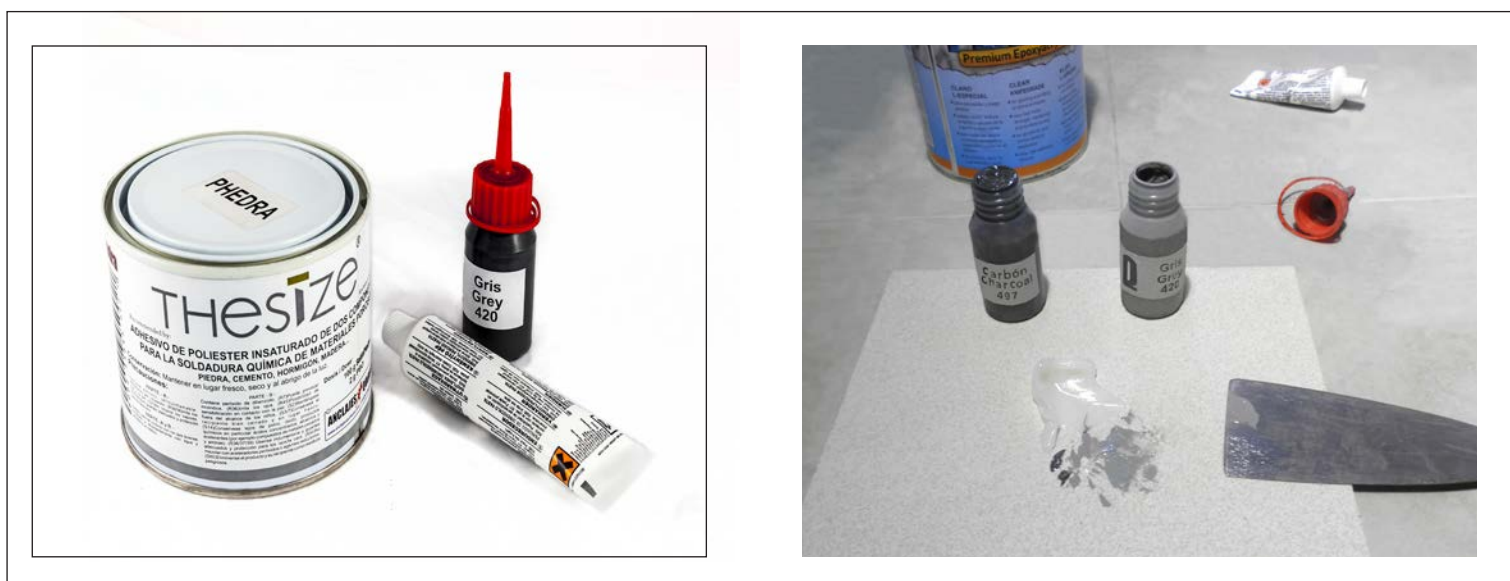

Image 27: Repairing Kit

Step 3:

Use a piece of Neolith to mimic the surface finish and proceed to fill the chip with the already mixed resin.

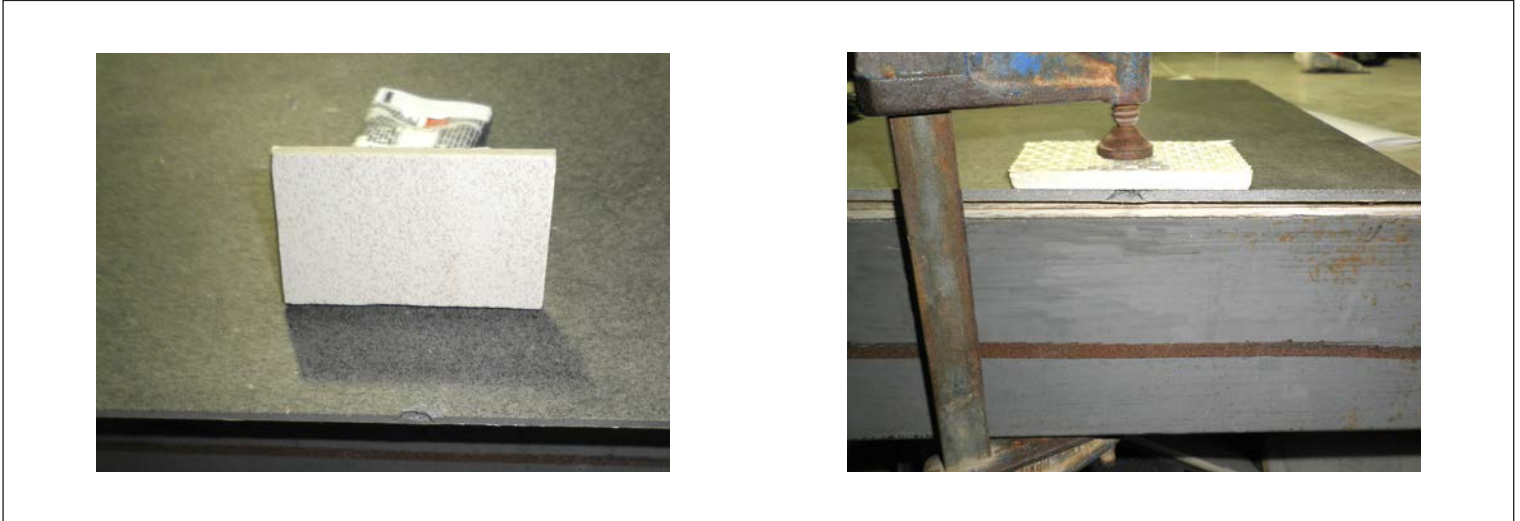

Image 28: Repairing process

Step 4:

Using a cloth soaked in acetone, additional texture can be added to the resin to further mimic the surrounding surface.

Make sure the level of the resin does not surpass the adjacent surface.

Clean the excess resin on the surface before it hardens, using a cloth soaked in acetone.

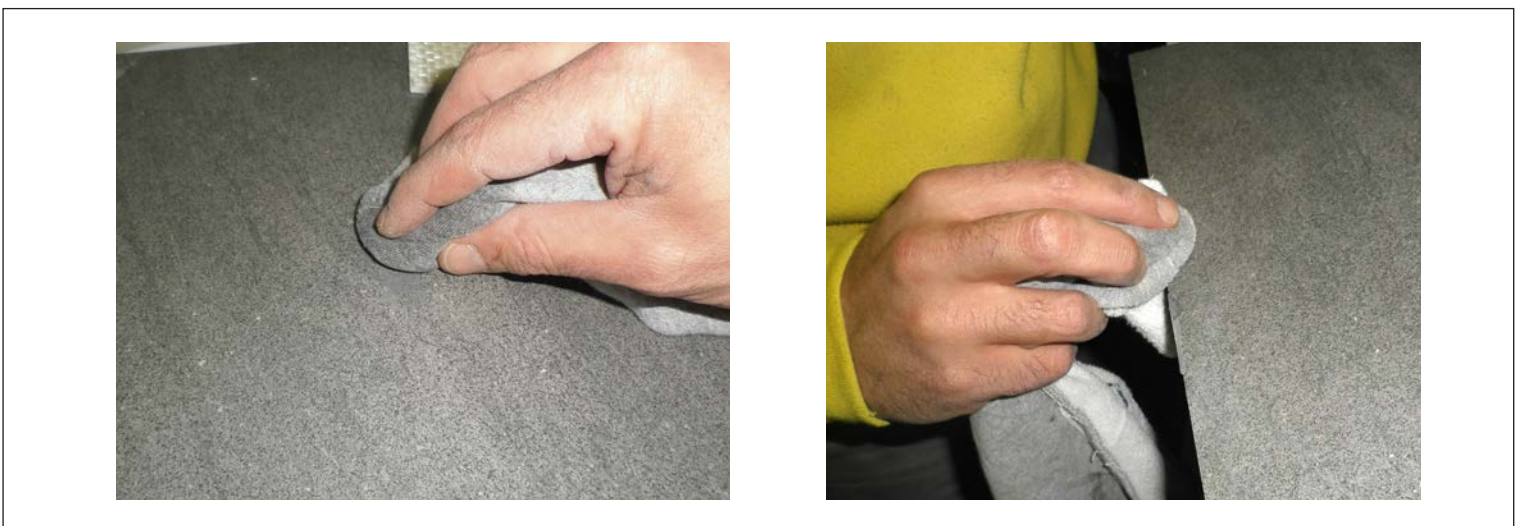

Image 29: Repairing process

Step 5:

Once the resin hardens, grind down the surplus resin on the edge mechanically, surface repairs are best grinded down manually to avoid damaging the surface.



Image 30: Repairing process



Do not hit your Neolith countertop with a blunt and heavy objects. It could chip or even break (the edges are the most sensitive to physical damage).

10. Durability Comparison Table:

Concept	Neolith	Neolith polished	Quartz Surfaces	Natural Stone	Laminate
Stain Resistance	✓✓✓	✓✓✓	✓✓✓	✓✓	✓
Heat and Burn Resistance	✓✓✓	✓✓✓	✓	✓✓	✓✓
Resistance to Household Chemicals	✓✓✓	✓✓✓	✓✓	✓✓	✓✓✓
Low Maintenance	✓✓✓	✓✓✓	✓✓	✓✓	✓
Non Absorbent and Nonporous	✓✓✓	✓✓✓	✓✓✓	✓✓	✓✓
Scratch Resistance	✓✓✓	✓✓	✓✓	✓✓	✓
Mold and Mildew Resistance	✓✓✓	✓✓✓	✓✓✓	✓✓	✓✓
Color Fastness	✓✓✓	✓✓✓	✓✓	✓✓✓	✓✓
Immunity to Freeze and Thaw	✓✓✓	✓✓✓	✓✓✓	✓✓✓	✓

Table 6: Durability comparison Table

NEOLITH
EXTRAORDINARY SURFACE

THESIZE SURFACES S.L.
P.I. Camí Fondo, Supoi 8. C/ Dels Ibers. 31
CP-12550 Almassora (Castellón) Spain
+34 964 652 233
info@thesize.es
www.neolith.com
